

Article number: 2310306561ESD

Description: E+G Antistatic base for levelling elements  
LV.A-125-24-M16x158-ESD-C

## Measures

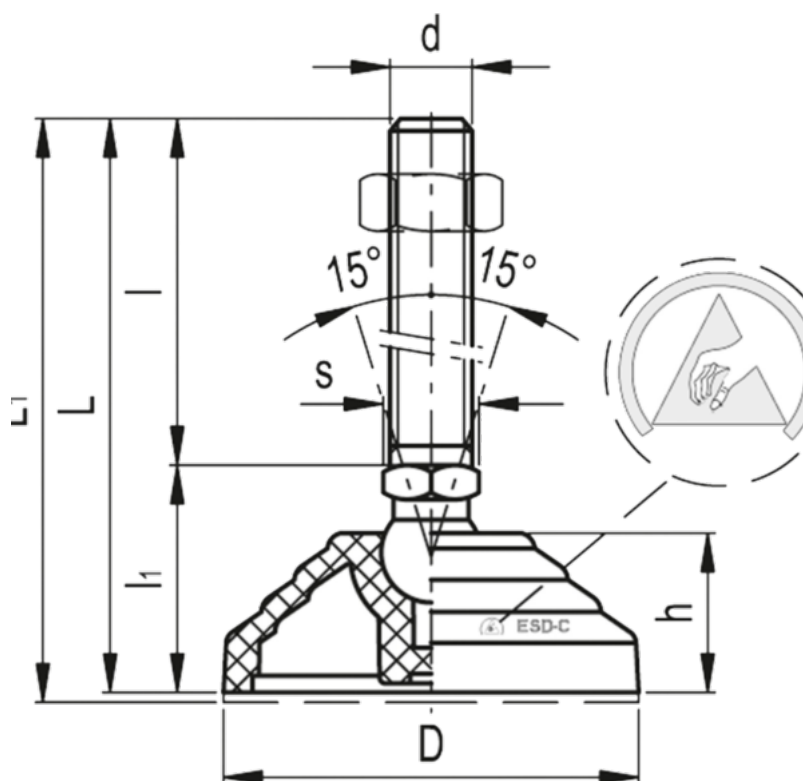

Articulation = 24  
D = 125  
d = M16  
h = 46  
l = -  
l1 = -  
L = 225  
Max load = 28000

s = 24  
Weight in (g) = 514